



***Save Energy - Save Money - Save Nature***



## Company Profile

SAM Electricals is committed to provide customers with defect-free products through our program of continuous improvement at a cost effective price. Quality shall, in every case, take precedence over quantity. This commitment to quality applies not just to our products, but to everything we do.

The best products and services are useless if they are not available when and where someone needs them. SAM Electricals commitment to availability extends throughout the organization, at all levels. SAM Electricals is committed to support our products and customers through industry-leading technical service, technical support and training, prompt and accurate answers to questions and handling of transactions, and timely follow-up on all matters.

SAM Electricals commitment to innovation means that we will evaluate and incorporate new technologies into our existing products, services, and processes to continuously improve value to our customers. SAM Electricals does not search for avant-garde technologies purely for the sake of change, but instead embraces innovations and solid solutions that make a difference. When SAM Electricals sets the industry standard for quality, availability, service, and innovation, the value offered by our products will be second to none. Located in the state of Uttarakhand, is spread in 11,000 square meters. The complete range of products is manufactured under supervision of highly qualified and skilled lamp industry engineers under very strict quality control measures, using ultra modern manufacturing and testing equipments.





# Index

1	Swinger	Page 4-5
2	Duster	Page 6-7
3	Aviator	Page 8-9
4	Rio	Page 10-11
5	Maple	Page 12-13
6	Sparkle	Page 14-15
7	Sparkle New	Page 16-17
8	Galaxy	Page 18-19
9	Glorious	Page 20-21
10	Xcent	Page 22-23
11	Sky Decor	Page 24
12	Star	Page 25
13	Sky	Page 26
14	Little	Page 27
15	Turbo Clean	Page 28
16	Tornado, Faratta	Page 29
17	LED Bulb	Page 31
18	Led Panel	Page 32
19	Led Ceiling Light	Page 33
20	Led Street & Flood Light	Page 35
21	LED Concealed Light	Page 36
22	MCB Box	Page 37
23	Change Over	Page 38
24	Modular Box	Page 39
25	Geysers & Immersion	Page 41
26	Wire & Cables	Page 42-44
27	PVC Conduit Pipe & Fitting	Page 45

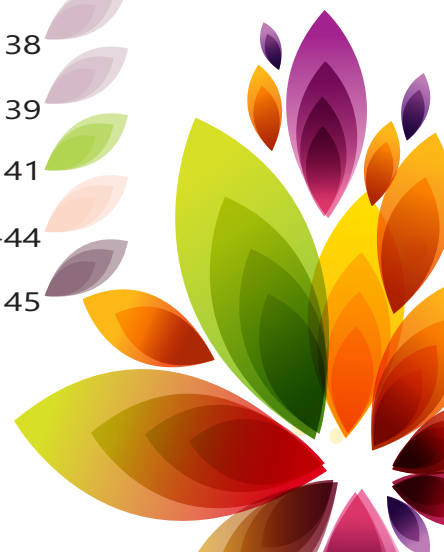

# Swinger



## Swinger

Available in 3 blades model with aerodynamically designed blades for maximum air thrust . Electroplated lacquered finish for a unique ethnic look.

High lift angle of blade for high speed and maximum air delivery . Elegant design of blade trims and canopies.



# Swinger



Energy saving

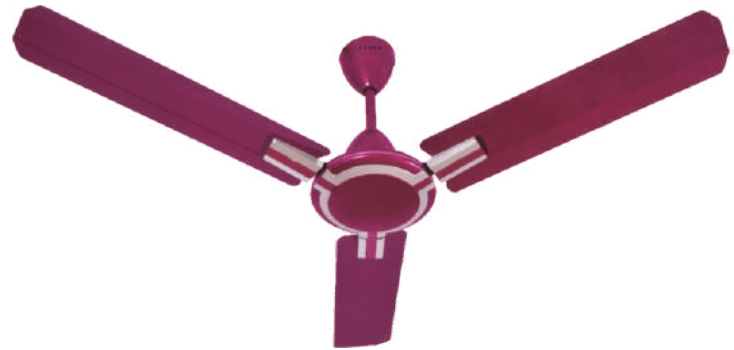

## Colours



New White



HD Brown



Orchid

Model	Sweep	Rated Speed (RPM)	Max. air Delivery (CMM)
Swinger	1200 MM	350	220

# Duster

## Duster

Available in 3 blades model with aerodynamically designed blades for maximum air thrust . Electroplated lacquered finish for a unique ethnic look. High lift angle of blade for high speed and maximum air delivery . Elegant design of blade trims and canopies.



Energy saving



## Colours



Briken Gold



Smokey Grey



New Wine

Model	Sweep	Rated Speed (RPM)	Max. air Delivery (CMM)
Duster	1200 MM	400	220

# Aviator



## Aviator

Cool exciting looks . wide tips blades for high air delivery and air spread. contrasting colour trims complements the ceiling. Superior metallic finish.



## Colours

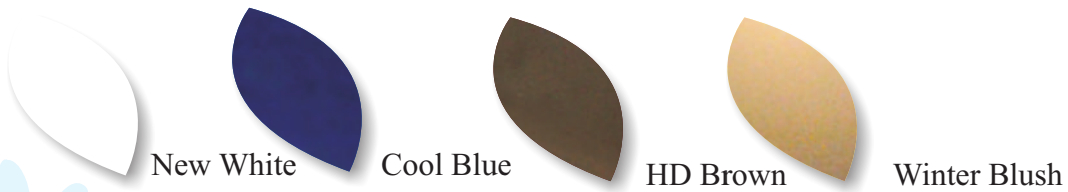

Model	Sweep	Rated Speed (RPM)	Max. air Delivery (CMM)
Aviator	1200 MM	350	220

# Rio

## Rio

Innovatively designed Broader and aerodynamically curved blades for maximum air delivery . Ornatly designed shanks and motor lends a look of elegance.

exceptionally beautiful colors available . Its wing specially designed to cover maximum area of the hall.



Colours



Orchid



Titanium



White

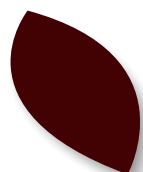

HD Brown

Model	Sweep	Rated Speed (RPM)	Max. air Delivery CMM
Rio	1200 MM	350	220



# Maple



## Maple

Wide tip blades for high air delivery and air spread. Ornately designed shanks and motor lends a look of elegance.



## Colours



Racing Copper



Silver



Pearl Ivory

Model	Sweep	Rated Speed (RPM)	Max. air Delivery (CMM)
Maple	1200MM	350	220

# Sparkle

## Sparkle

High lift angle of blade for wide air spread . Smooth floral designed motor and blades. Unique decorative shanks and canopies and motor.



## Colours



Oyster



Silver Blue

Model	Sweep	Rated Speed (RPM)	Max. air Delivery (CMM)
Sparkle	1200 MM	350	220

Sparkle New



## Sparkle New

Exclusively new metalised blade and motor trims which gives the fan amazing look.



## Colours

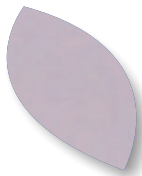

Silver Blue

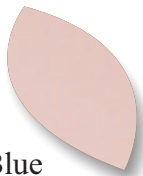

Oyester

Model	Sweep	Rated Speed (RPM)	Max. air Delivery (CMM)
Sparkle	1200 MM	350	220

## Galaxy

Extreme wide tip blades for maximum air thrust . Highly elegant Matte finish liquid paint for better aesthetics . Available in 2 beautiful colours .

# Galaxy

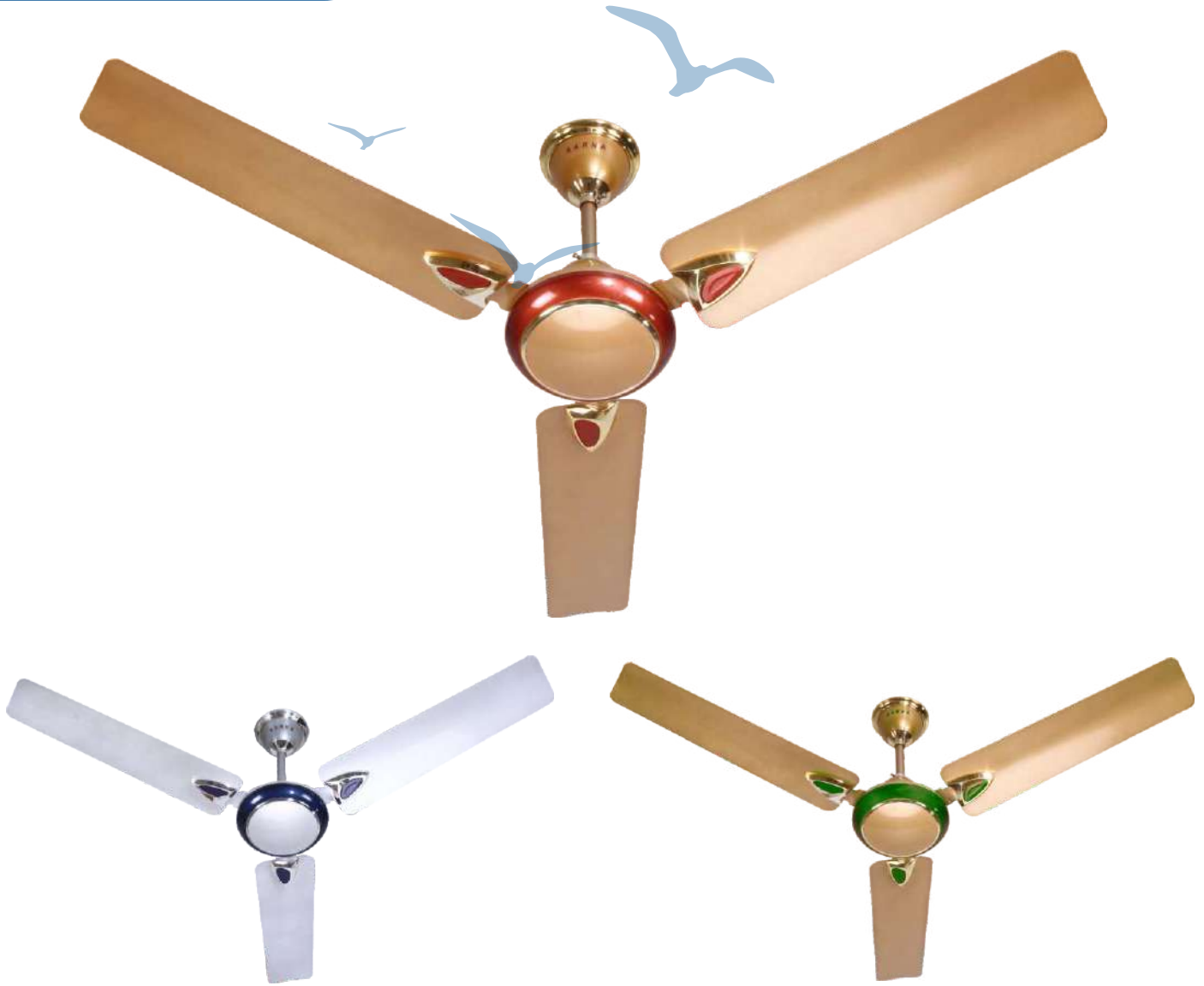

## Galaxy

Extreme wide tip blades for maximum air thrust . Highly elegant Matte finish liquid paint for better aesthetics . Available in 2 beautiful colours .

### Colours



Model	Sweep	Rated Speed (RPM)	Max. air Delivery (CMM)
Galaxy	1200 MM	400	230

# Glorious



## Glorious

Roman design with beautifully aligned petal shaped blades.



## Colours



Sand Silk



Phantom Black

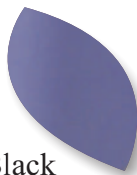

Sweet Lavender



Monsoon Green

Model	Sweep	Rated Speed (RPM)	Max. air Delivery (CMM)
Glorious	1200 MM	390	200





## Xcent

Xcent: ornately designed with attractive shanks and elegant broader blades . Available in powder/ metallic paint.



## Colours



Phantom Black



White



Monsoon Green

Model	Sweep	Rated Speed (RPM)	Max. air Delivery (CMM)
Xcent	1200 MM	350	220





## Sky Decor

3 step design motor . uniquely shaped , decorative shanks on blades. Attractive yet simple trim on motor.

### Colours



Model	Sweep	Rated Speed (RPM)	Max. air Delivery (CMM)
Sky Decor	1200 MM	350	210

# Star



## Star

Aerodynamically designed for wide air spread .  
Glossy powder coated paint for superior finish and longer life.

Performs well even at low voltage.

## Colours



White



Matte / Brown



Ivory

Model	Sweep	Rated Speed (RPM)	Max. air Delivery (CMM)
Star	600 MM	830	100
	900 MM High Speed	630	140
	1200 MM	390	210
	1400 MM	350	230



## Sky

High lift Angle of Blades for high speed and maximum air delivery. Elegant simple design.

### Colours



Matte / Brown



White



Ivory

Model	Sweep	Rated Speed (RPM)	Max. air Delivery (CMM)
Sky	600 MM	830	100
	900 MM	410	140
	1200 MM	350	210
	1400 MM	350	230



### Colours



Silver Bl.



Golden



Brown



White

Model	Sweep	Rated Speed (RPM)	Max. air Delivery (CMM)
Little	600 MM	850	140 230

# Turbo Clean



Model	Sweep	Rated Speed (RPM)
Ventilator	150 MM	1350
Ventilator	200 MM	1350
Ventilator	250 MM	1350



Model	Sweep	Rated Speed (RPM)
Trans Air	230 MM	1350
Trans Air	300 MM	1350



Model	Sweep	Rated Speed (RPM)
Exhaust Fan	300 MM	1350
Exhaust Fan	380 MM	1350
Exhaust Fan	450 MM	1350



Model	Sweep	Rated Speed (RPM)
Fresh Air	230 MM	2150
fresh Air	300 MM	2150

# Tornado



Model	Sweep	Rated Speed (RPM)
-------	-------	-------------------

Tornado	400 MM	1350
---------	--------	------



Model	Sweep	Rated Speed (RPM)
-------	-------	-------------------

Tornado	400 MM	1350
---------	--------	------



Model	Sweep	(RPM)
-------	-------	-------

Hi-Flo	500 MM	1400
--------	--------	------



Model	Sweep	(RPM)
-------	-------	-------

Thunder	500 MM	2800
---------	--------	------





Model	Sweep	(RPM)
-------	-------	-------

Bullet Farrata	400 MM	2300
----------------	--------	------





# LED Bulbs & Batten

PRODUCT IMAGE	DOWNLIGHTS RANGE	POWER (W)	LUMENS (lm)	BODY	SHAPE	COLOR	CUTOUT SIZE(mm)
	PING PONG ROUND - SPHERE	0.5	20	Plastic	Round	W/R/B/G/Y/O/P	45X71
	TWINKLE - CANDLE	0.5	10	Plastic	Candle	W/R/B/G/Y	34X85
	ULTRA HIGH DEFINITION	3w	270	Thermal Plastic with Aluminum Inside	A54	WW/CDL	52x90
		5w	475		A57	WW/CDL	60x110
		7w	665		A57	WW/CDL	60x110
		9w	855		A57	WW/CDL	70x124
		12w	1200		A68	WW/CDL	68x127
		14w	1400		A68	WW/CDL	68x127
		18w	1800		A80	WW/CDL	81x153
		23w	2300		A80	WW/CDL	81x153











TUBE LIGHT RANGE	POWER (W)	LUMENS (lm)	BODY	SHAPE	COLOR	CUTOUT SIZE(mm)
T-5-SMART BEE LINE	18	1800	Plastic	Complete Plastic	WW/CW	4ft
T-5-SMART BEE LINE	10	1000	Plastic	Complete Plastic	WW/CW	2ft

# LED Panels



## LED ALUMINIUM PANEL

PRODUCT IMAGE	SLEEK PANEL RANGE	POWER (W)	LUMENS (lm)	BODY	SHAPE	COLOR	CUTOUT SIZE(mm)
	SLEEK ROUND	3w	160	PDC Aluminum+Glass	Round	WW/CW/NW	75
		6w	360	PDC Aluminum+Glass	Round	WW/CW/NW	108
		9w	540	PDC Aluminum+Glass	Round	WW/CW/NW	135
		12w	820	PDC Aluminum+Glass	Round	WW/CW/NW	155
		15w	1050	PDC Aluminum+Glass	Round	WW/CW/NW	205
		18w	1280	PDC Aluminum+Glass	Round	WW/CW/NW	205
		24w	1750	PDC Aluminum+Glass	Round	WW/CW/NW	280
	SLEEK SQUARE	3w	160	PDC Aluminum+Glass	Square	WW/CW/NW	75x75
		6w	360	PDC Aluminum+Glass	Square	WW/CW/NW	108x108
		9w	540	PDC Aluminum+Glass	Square	WW/CW/NW	135x135
		12w	820	PDC Aluminum+Glass	Square	WW/CW/NW	155x155
		15w	1050	PDC Aluminum+Glass	Square	WW/CW/NW	176x176
		18w	1280	PDC Aluminum+Glass	Square	WW/CW/NW	205x205
		24w	1750	PDC Aluminum+Glass	Square	WW/CW/NW	280x280

## LED PLASTIC PANEL



PRODUCT IMAGE	SLEEK PANEL RANGE	POWER (W)	LUMENS (lm)	BODY	SHAPE	COLOR	CUTOUT SIZE(mm)
	PLASTIC ROUND	6	360	Poly Carbonate	Round	WW/CW/NW	120x25
		12	840	Poly Carbonate	Round	WW/CW/NW	170x25
		18	1350	Poly Carbonate	Round	WW/CW/NW	225x25
							
	PLASTIC SQUARE	6	360	Poly Carbonate	Round	WW/CW/NW	120x25
		12	840	Poly Carbonate	Round	WW/CW/NW	170x25
		18	1350	Poly Carbonate	Round	WW/CW/NW	225x25
		 Ultra efficient LED light source, saves up to 80% energy vs traditional lighting  No harmful UV/IR radiation  Durable aluminum housing  Cut out size decrease  Common output size for an easy switch from conventional down lights  Up to 15 times long life compared to incandescent light sources  Save Energy					

## LED SURFACE PANEL



PRODUCT IMAGE	LED SURFACE PANEL RANGE	POWER (W)	LUMENS (lm)	BODY	SHAPE	COLOR	CUTOUT SIZE(mm)
	ELEGANT ROUND	6w	360		Round	WW/CW	122x122x38
		12w	840		Round	WW/CW	172x172x38
		13w	1320		Round	WW/CW	216x216x38
		24w	1750		Round	WW/CW	300x300x38
	ELEGANT SQUARE	6w	360		Square	WW/CW	122x122x38
		12w	840		Square	WW/CW	172x172x38
		13w	1320		Square	WW/CW	216x216x38
		24w	1750		Square	WW/CW	300x300x38

# LED Ceiling Lights

## LED CEILING LIGHT

PRODUCT IMAGE	CEILING LIGHT RANGE	POWER (W)	LUMENS (lm)	BODY	SHAPE	COLOR	CUTOUT SIZE(mm)
	RECESSED BACKLIT 2ftX2ft	42	4200	Powder Coated CRC Sheet with PMMA diffuser	Square	WW/CW	595x595
	RECESSED /SUSPENDED EDGELIT 2ftX2ft	42	4200	Aluminum with PMMA diffuser	Square	WW/CW	575x575

## COB LIGHTS

PRODUCT IMAGE	DOWNLIGHTS RANGE	POWER (W)	LUMENS (lm)	BODY	SHAPE	COLOR	CUTOUT SIZE(mm)
	SPARKLE	6w	360	PDC Aluminum with poly carbonate cabinet for driver	Round	WW/CW	85xH60
		9w	630	PDC Aluminum with poly carbonate cabinet for driver	Round	WW/CW	95xH60
		15w	1125	PDC Aluminum with poly carbonate cabinet for driver	Round	WW/CW	95xH60
	ILLUMINE	24w		PDC Aluminum with poly carbonate cabinet for driver	Round	WW/CW	158x90
		30w		PDC Aluminum with poly carbonate cabinet for driver	Round	WW/CW	158x108





# Led Street Lights



## Specification

Available Wattages	20W 25W 40W 60W 90W 120W 150W
Color Temperature	6500K 3000K
Dispersion angle	>120°
Power Factor & Surge Protection	PF >0.95 and Upto 5.0KV surge
Lumens / Watt	≥100
Input Voltage	AC 100 - 300 V
Base	Pole Mount
Color Rendering Index (CRI)	>80
Total Harmonic Distortion (THD)	<10%
IP Rate	IP66/IP65



Heavy Duty Aluminium body with Premium Satin finish

Heavy Duty LED Driver

Easy Smooth Installation



Input Voltage 100V - 300V with 5.0KV Surge

50000 HOURS

SERVICE LIFE



ENERGY SAVING



HIGH BRIGHTNESS



# Led Flood Lights



## Specification

Available Wattages	20W 30W 50W 100W 150W 200W
Color Temperature	6500K 3000K
Dispersion angle	>45° >60° >90° >120°
Power Factor & Surge Protection	PF >0.95 and 5.0KV surge
Lumens / Watt	≥100
Input Voltage	AC 100 - 300 V
IP Rate	IP66/IP65
Color Rendering Index (CRI)	>80
Total Harmonic Distortion (THD)	<10%
External Protection	10KVA / 20KVA



Heavy Duty Aluminium body with Premium Satin finish

Heavy Duty LED Driver

Easy Smooth Installation



Input Voltage 100V - 300V with 5.0KV Surge

50000 HOURS

SERVICE LIFE



ENERGY SAVING



HIGH BRIGHTNESS



# LED Concealed Light

*Orbit*



Genetic Name : LED Downlighter	Outer Dimension : 100mmx35mm
Rated Voltage : 230V,50Hz,AC	Cutout Dimension : 85mm
Lumen Output** : 420 lm	Rated Wattage : 3W/5W

*Sparkle New*



Genetic Name : LED Downlighter	Outer Dimension : 100mmx35mm
Rated Voltage : 230V,50Hz,AC	Cutout Dimension : 85mm
Lumen Output** : 420 lm	Rated Wattage : 6W

*Junior Pc*



Genetic Name : LED Downlighter	Outer Dimension : 75mmx25mm
Rated Voltage : 230V,50Hz,AC	Cutout Dimension : 50mm
Lumen Output** : 210 lm	Rated Wattage : 3W

*Moon Light Round*



Genetic Name : LED Downlighter	Outer Dimension : 80mmx25mm
Rated Voltage : 230V,50Hz,AC	Cutout Dimension : 60mm
Lumen Output** : 500,700 lm	Rated Wattage : 5W/7W

*Twinkle*



Genetic Name : LED Downlighter	Outer Dimension : 100mmx35mm
Rated Voltage : 230V,50Hz,AC	Cutout Dimension : 85mm
Lumen Output** : 280, 420 lm	Rated Wattage : 4W/6W

*Moon Light Square*



Genetic Name : LED Downlighter	Outer Dimension : 80mmx25mm
Rated Voltage : 230V,50Hz,AC	Cutout Dimension : 60mm
Lumen Output** : 500,700 lm	Rated Wattage : 5W/7W

**Features**

- Space saving design. • Ultra Slim Construction.
- Durable Aluminium Housing. • Robust LED-Driver, delivery longer life.
- Eye Protection, provided by acrylic diffuser from the glare.







Bright Light + Power Saver + Long Life + Green Product + Safer Eyes

# MCB Distribution Box



## Salient Features

- Made of special grade CRCA Sheet steel to provide strength and longer life to enclosures.
- Coated with latest powder coating technology for long lasting life & Mounting finish.
- Current carrying parts are made of electrolytic grade of copper to attain high conductivity and low resistivity thereby keeping temperature rise and distribution losses very low.
- Adequate number of knockout holes of various sizes are provided both at top & bottom.
- Designer Double Door : both sides detachable gland plates with knockouts and masking sheet provided.
- Cement Spill protector.
- Ample ( Sufficient ) wiring space is provided to ensure proper distribution of neutral and earth wires.
- Wide range of distribution boards used for different applications.
- Suitable for surface & flush mounting.
- Decorative Side Strip Fitted.

## Range (Adjustable / Non Adjustable)

SPN – 4, 6, 8,10,12,16,18, 20Ways

TPN – 4, 6, 8,12Ways

Colours :- White

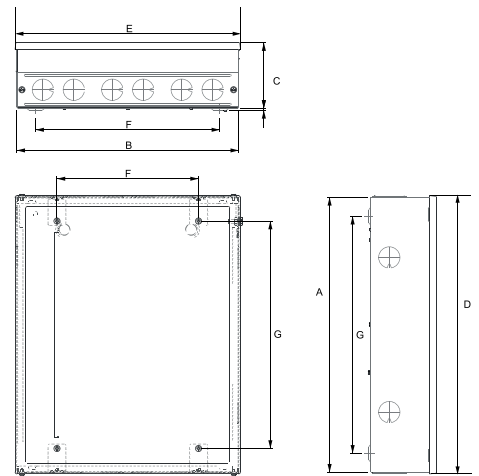
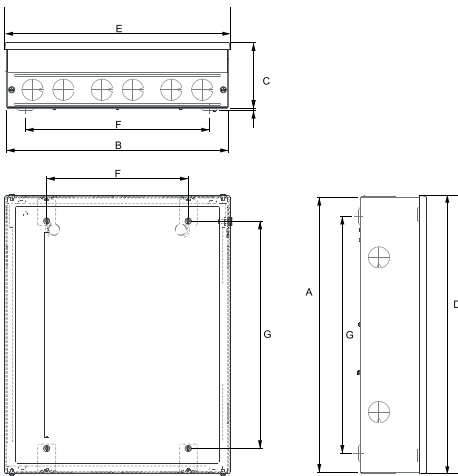

## DECORATIVE SERIES - SPN - Dimensions (in mm)

No. of Ways	A	B	C Non Adj./Adj	D	E	F	G
4	210	145	85/100	225	175	80	150
6	210	180	85/100	225	210	115	150
8	210	215	85/100	225	245	150	150
10	210	250	85/100	225	280	185	150
12	210	285	85/100	225	315	220	150
16	210	355	85/100	225	385	290	150
18	210	390	85/100	225	420	325	150
20	210	425	85/100	225	455	360	150

## DECORATIVE SERIES - TPN - Dimensions (in mm)

No. of Ways	A	B	C	D	E	F
4	385	260	398	285	182	308
6	385	330	398	355	252	308
8	385	400	398	425	322	308
12	385	540	398	565	462	308

# Change Over Switches



## Salient Features

- Made of special grade CRCA Sheet steel to provide strength and longer life to enclosures.
- Coated with latest powder coating technology for long lasting life & Mounting finish.
- Current carrying parts are made of electrolytic grade of copper to attain high conductivity and low resistivity thereby keeping temperature rise and distribution losses very low.
- Adequate number of knockout holes of various sizes are provided both at top & bottom.
- Designer Double Door : both sides detachable gland plates with knockouts and masking sheet provided.
- Cement Spill protector.
- Ample ( Sufficient ) wiring space is provided to ensure proper distribution of neutral and earth wires.
- Wide range of distribution boards used for different applications.
- Suitable for surface & flush mounting.
- Decorative Side Strip Fitted.

## Range (Adjustable / Non Adjustable)

DP - 32, 63  
 TP - 32, 63, 100  
 Colours : White

## Switchgear Specifications

S.No.	Model	Description	Pole	Pack
1	Change Over	32x240	D.P.	8
2	Change Over	32x415	F.P.	8
3	Change Over	63x240	D.P.	8
4	Change Over	63x415	F.P.	4
5	Change Over	100x415	F.P.	4
6	Main Switch	32x240	D.P.	8

# Modular Boxes



G.I. ( Galvanised Iron) Sheet Boxes in White Color  
18 / 20 Gauge Sheet Used

All Sizes Available in Modular and Ordinary Fitting

## G.I. BOXES

S.No.	Pack	Size (Inch)	Module
1	96	3 x 3	1/2
2	72	4 x 3	3
3	56	5 x 3	4
4	30	8 x 3	6
5	28	5 x 5	8 v
6	32	9 x 3	8 H
7	20	8 x 6	12
8	12	8 x 8	18



## Black Powder coated fan box

G.I. ( Galvanised Iron) Sheet Boxes  
Nerolac Powder Coated  
18 / 20 Gauge Sheet Used



## Black Powder coated concealed box

G.I. ( Galvanised Iron) Sheet Boxes  
Nerolac Powder Coated  
18 / 20 Gauge Sheet Used  
Available in 3 & 4 inches.



# GAS GEYSER & IMMERSION ROD



15, 25 & 35 Litre



1,3,10,15 & 25 Litre

## WATER HEATER

Stationary Storage Type  
Electric Water Heater

### Features

- Multiple Safety System.
- Hydraulically Pressure Tested Tank.
- Neon Lamp for Heating and Thermal Cut-out.
- Super Efficient & Long lasting Heavy Element.
- Corrosion Resistant MS Sheet Body.
- 12 Months Guarantee on Electrical components & 5 Year Guarantee on Inner Tank.

S.No.	Type	Capacity	Packing
1	Metal	15	1
2	Metal	25	1
3	Metal	35	1
4	ABS	1	2
5	ABS	3	2
6	ABS	10	2
7	ABS	15	1
8	ABS	25	1

IS : 2082



### Features

- Water Proof
- Fully Submersible Immersion
- Copper Tube Element
- Long lasting Plating
- Longer Element Life
- Special Design for Safe Use

SAFETY



IS:302-2-201  
CM/L-8980104



S.No.	Type	Wattage	Packing
1	Normal	1000	72
2	Normal	1500	72
3	Normal	2000	72
4	Water Proof	1000	72
5	Water Proof	1500	72
6	Water Proof	2000	72



CABLES WITH IMPROVED FIRE PERFORMANCE



ANNEALED COPPER ETP GRADE  
101% CONDUCTIVITY (IACS) USED



# Electrical Wires & Cables

Aarna Single Core FR PVC Insulated Industrial Grade Copper Conductor Flexible Cables (**Multistrand**), 1100 Volts Confirming IS:694

90 Mtrs

Sr. No.	Size (Sq. mm)	Packing	Rate(₹)
1	0.75	20	
2	1.00	20	
3	1.50	16	
4	2.50	12	
5	4.00	4	
6	6.00	4	
7	10.00	1	
8	16.00	1	
9	25.00	1	
10	35.00	1	
11	50.00	1	

Aarna **Solidstrand (Old Type)** Single Core (Twisted) FR PVC Insulated Industrial Grade Copper Conductor Flexible Cables 1100 Volts Confirming IS:694

90 Mtrs

Sr. No.	Nos. of Wire (MM)	Diameter of Wire (MM)	Nos. X SWG	Nominal Area of Conductor (Sq. MM)	Current Rating AMP	Rate (₹)
12	7	1.05	7 X 18	6.0	38	
13	7	1.71	7 X 16	16.0	69	
14	7	2.14	7 X 14	25.0	88	
15	19	1.04	19 X 18	16.0	69	
16	19	1.54	19 X 16	35.0	106	
17	19	2.16	19 X 14	70.0	200	
18	37	1.56	37 X 16	70.0	200	
19	37	2.04	37 X 14	120.0	270	

Aarna PVC Insulated **Flexible Twin Twisted** Cables Copper Conductor

90 Mtrs

Sr. No.	Size (SWG)	CODE	Rate(₹)
20	14/76 BC	503	

Aarna **Multicore Round Flexible** PVC Insulated & FR PVC Round Sheathed, Copper Conductor Industrial Cable, 1100 Volts Confirming IS:694

90 Mtrs

**2 Core**

Sr. No.	Nominal Size (Sq. mm)	No. of Strands	Rate(₹)
21	0.50	16	
22	0.75	24	
23	1.00	32	
24	1.50	48	
25	2.50	80	
26	4.00	128	
27	6.00	84	
28	10.00	140	

## 3 Core

90 Mtrs

Sr. No.	Nominal Size (Sq. mm)	No. of Strands	Rate(₹)
29	0.50	16	
30	0.75	24	
31	1.00	32	
32	1.50	48	
33	2.50	80	
34	4.00	128	
35	6.00	84	
36	10.00	140	
37	16.00	226	

## 4 Core

90 Mtrs

38	0.50 Sq. mm	16	
39	0.75 Sq. mm	24	
40	1.00 Sq. mm	32	
41	1.50 Sq. mm	48	
42	2.50 Sq. mm	80	
43	4.00 Sq. mm	128	
44	6.00 Sq. mm	84	
45	10.00 Sq. mm	140	
46	16.00 Sq. mm	226	

Aarna Flat Three Core PVC Insulated and PVC Sheathed Industrial Cables for **Submersible** Pump Motors, 1100 Volts Confirming IS:694

Sr. No.	Size (Sq. mm)	500 Mtrs (Rate ₹)	100 Mtrs (Rate ₹)
47	1.50 Sq. mm		
48	2.50 Sq. mm		
49	4.00 Sq. mm		
50	6.00 Sq. mm		
51	10.00 Sq. mm		
52	16.00 Sq. mm		

Aarna PVC Insulated **Unsheathed, Sheathed, Flat Twin** Industrial Grade Aluminium Cables, 1100 Volts Confirming IS:694

## Solid Conductor

Sr. No.	Size (Sq. mm)	Unsheathed (100 Mtrs. Rate ₹)	Sheathed (100 Mtrs. Rate ₹)	Twin Flat (90 Mtrs. Rate ₹)	Round Twin (90 Mtrs. Rate ₹)
53	1.50 Sq. mm				
54	2.50 Sq. mm				
55	4.00 Sq. mm				
56	6.00 Sq. mm				
57	10.00 Sq. mm				



# Electrical Wires & Cables

## Stranded Conductor

Sr. No.	Size (Sq. mm)	Unsheathed (100 Mtrs. Rate ₹)
58	1.50 Sq. mm	
59	2.50 Sq. mm	
60	4.00 Sq. mm	
61	6.00 Sq. mm	
62	10.00 Sq. mm	
63	16.00 Sq. mm	
64	25.00 Sq. mm	
65	35.00 Sq. mm	
66	50.00 Sq. mm	
67	70.00 Sq. mm	
68	95.00 Sq. mm	
69	120.00 Sq. mm	

Aarna **Unarmoured Multicore Round PVC Insulated & PVC Round Sheathed Industrial Grade Aluminium Cables, 1100 Volts** Confirming IS:694

Sr. No.	Size (Sq. mm)	450 Mtrs (Rate ₹)	90 Mtrs (Rate ₹)
70	10 Sq - 3C		
71	10 Sq - 4C		
72	16 Sq - 4C		
73	25 Sq - 4C		
74	35 Sq - 4C		
75	50 Sq - 4C		

Aarna **Computer LAN Network Cable, Electrolytic Grade Copper Conductor, 4 Pair Unshielded Twisted Pair (UTP) Industrial Cable for LAN Network** **305 Mtrs**

Sr. No.	Size (Sq. mm)	Item	Rate (₹)
<b>NEW</b> 76	4 Pair With Star Separator	CAT 6	
<b>NEW</b> 77	4 Pair With Star Separator	CAT 5	

Aarna **CCTV Camera Cable, Copper Conductor, PVC Insulated, AL. Foiled And AL. Wire Braided** **90 Mtrs**

Sr. No.	Size (Sq. mm)	Item	Rate (₹)
78	14/0052	3 + 1	
79	14/0052	4 + 1	

Aarna **CCTV Co-Axial Cables, Electrolytic Grade Solid Annealed Copper Conductor, Jelly Filled, AL. Foiled & AL. Braided**

Sr. No.	Nominal Size (Sq. mm)	Length	Rate (₹)
80	RG -6 Foam, JF,AL Foil+ AL. Braided	90 Mtr	
81	RG -6 Foam, JF,AL Foil+ AL. Braided	305 Mtr	
82	RG -6 CCS Foam, JF,AL Foil+ AL. Braided	90 Mtr	
83	RG -6 CCS Foam, JF,AL Foil+ AL. Braided	305 Mtr	

Aarna PVC Insulated **Telephone Cables** for indoor applications conforming to TEC specification G/WIR06/02

**90 Mtrs**

Sr. No.	Code	Rate (₹)
84	1 Pair	
85	2 Pair	
86	3 Pair	
87	4 Pair	
88	5 Pair	
89	6 Pair	
90	8 Pair	
91	10 Pair	
92	15 Pair	
93	20 Pair	

## Armoured Cables Aluminium

100 Mtrs & 300 Mtrs

Sr. No.	Size (Sq. mm)	Rate (₹) (Per Mtr.)
94	4 Sq. mm X 2 Core	
95	6 Sq. mm X 2 Core	
96	6 Sq. mm X 3 Core	
97	6 Sq. mm X 4 Core	
98	10 Sq. mm X 2 Core	
99	10 Sq. mm X 4 Core	
100	16 Sq. mm X 2 Core	
101	16 Sq. mm X 4 Core	
102	25 Sq. mm X 4 Core	
103	35 Sq. mm X 3.5 Core	
104	35 Sq. mm X 4 Core	
105	50 Sq. mm X 3.5 Core	
106	50 Sq. mm X 4 Core	
107	70 Sq. mm X 3.5 Core	
108	70 Sq. mm X 4 Core	
109	95 Sq. mm X 3.5 Core	
110	95 Sq. mm X 4 Core	
111	120 Sq. mm X 3.5 Core	
112	150 Sq. mm X 3.5 Core	
113	185 Sq. mm X 3.5 Core	
114	240 Sq. mm X 3.5 Core	

## Armoured Cables Copper

100 Mtrs & 300 Mtrs

Sr. No.	Size (Sq. mm)	Rate (₹) (Per Mtr.)
115	1.5 Sq. mm X 2 Core	
116	1.5 Sq. mm X 3 Core	
117	1.5 Sq. mm X 4 Core	
118	2.5 Sq. mm X 2 Core	
119	2.5 Sq. mm X 3 Core	
120	2.5 Sq. mm X 4 Core	
121	2.5 Sq. mm X 5 Core	
122	4 Sq. mm X 2 Core	
123	4 Sq. mm X 3 Core	
124	4 Sq. mm X 4 Core	
125	6 Sq. mm X 2 Core	
126	6 Sq. mm X 3 Core	
127	6 Sq. mm X 4 Core	
128	10 Sq. mm X 2 Core	
129	10 Sq. mm X 3 Core	
130	10 Sq. mm X 4 Core	
131	16 Sq. mm X 2 Core	
132	16 Sq. mm X 4 Core	

# PVC CONDUIT PIPE & FITTING

## SALIENT FEATURES

- Adaptable to standard concealed wiring system as per IS: & BS:
- Virgiri suspension grade K-67 PVC.
- Processed on twin screws extrudes.
- Minimum filler ensures high impact strength.
- Unplasticised PVC Formulation to Improve the mechanical strength.
- UV stabilised

## MECHANICAL PROPERTIES

- Percentage of Compression with specified load less 25%
- Percentage of Compression without load than 10%
- High Impact Strength
- Tensile Strength-390-420kG./cm<sup>2</sup>

## THERMAL PROPERTIES

- Working Temperature = 70°C
- Burring Rate = Self Extinguishing
- Flammability = UL94V-0
- Flame Die Out Time = Less than 30 Sec.

## ELECTRICAL PROPERTIES

- Dielectrical Strength = 36 Kv/mm
- Specific Resistance =  $6.1 \times 10^{14}$  ohm cm
- Electric Strength = No breakdown at 2 Kv x 50 hz. for 15 minutes

## Low Halogen SFT (FRLS) Rigid PVC Conduits

- **Flame Retardant & Temperature Stable** (No Propagation of flame & thermal stability more than 60 minutes at 200°C)
- **Halogen Free (Non-Toxic)** Hydrochloride Acid contents less than 19%, Oxygen index more than 29%
- **Smoke free/very low smoke** Smoke density rating less than 60%

**SIZE AVAILABLE** : 20mm, 25mm, 32mm, 40mm, 50mm, & 63mm

**MECHANICAL STRENGTH** : Light (LMS) Medium (MMS) & Heavy (HMS)

**COLORS** : Ivory, Grey & Black

- Sizes available 20, 25, 32, 40 & 50 mm
- Surface & deep junction box in one way, two way, three way & four way configuration
- All junction boxes are provided with brass inserts & covers



## DIMENSIONS

S.No.	Normal Size (in mm)	Normal O.D. (in mm)	Normal O.D. (in mm)	MINIMUM INTERNAL DIAMETER		
				Light Mechanical Strength (in mm)	Medium Mechanical Strength (in mm)	Heavy Mechanical Strength (in mm)
1.	20	19.70	17.40	17.40	16.90	15.80
2.	25	24.60	22.10	22.10	21.40	20.60
3.	32	31.60	28.60	28.60	27.80	26.60
4.	40	39.60	35.80	35.80	35.40	34.40
5.	50	49.50	45.10	45.10	44.30	43.20
6.	63	62.40	57.00	57.00	-----	-----





## **SAM MARKETING COMPANY**

**Corp. Office :**

27,28,29/43-44, UPSIDC Industrial Area, Amrit Steel Compound, South Side, .  
G.T. Road, Ghaziabad-201001 (U.P) | Email : [info@aarnalights.com](mailto:info@aarnalights.com)

[www.aarnalights.com](http://www.aarnalights.com)